

動物侵入防止柵用クリップ金網 S=1/20

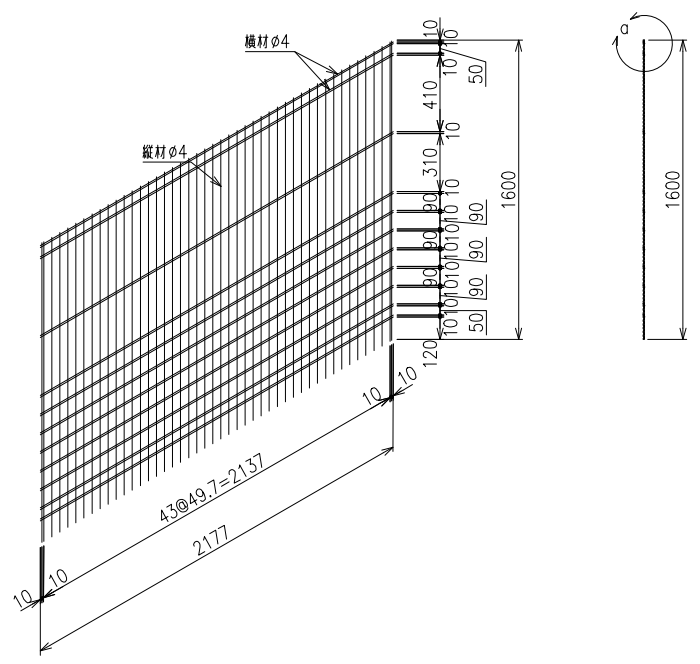

0部詳細図 S=1/4

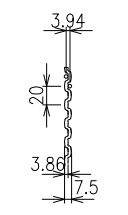

クリップ金網取付詳細図 S=1/3

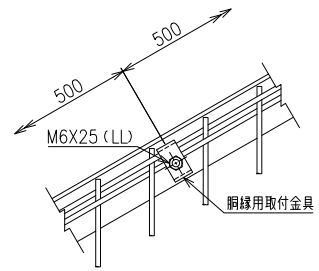

A部詳細図 S=1/4

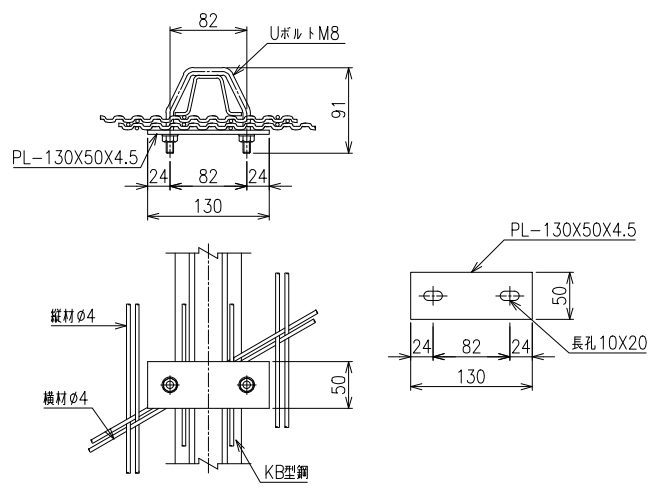

主柱骨線取付部 S=1/4

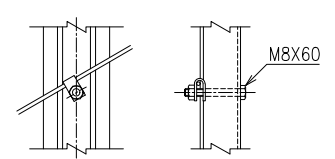

Uボルト、ナット S=1/2

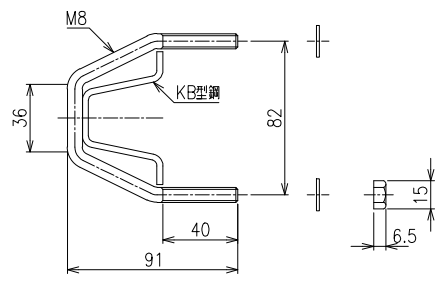

主柱KB型鋼 S=1/2

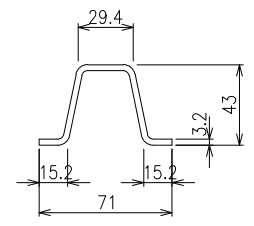

胴縁 S=1/2

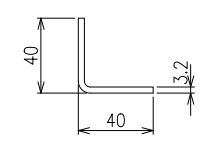

主柱胴縁取付詳細図 S=1/4

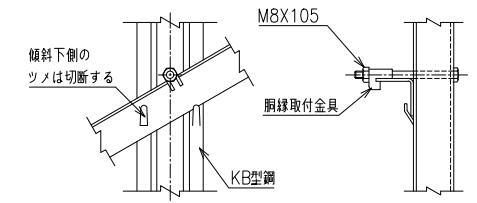

胴縁取付金具 S=1/1

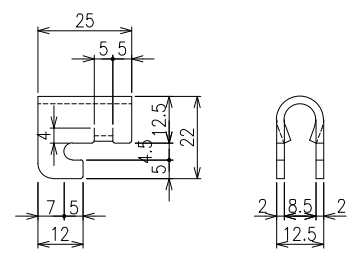

胴縁用金網取付金具 S=1/2

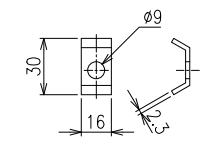

U字金具 S=1/2

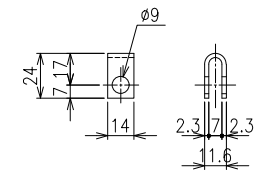

胴縁 S=1/4

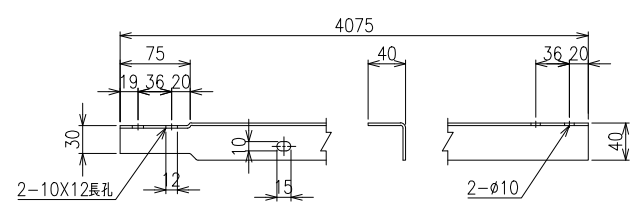

胴縁継手詳細図 S=1/4

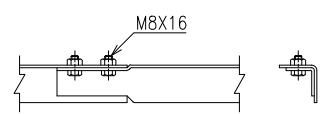

\*出力する用紙サイズにより、表示された縮尺とは異なる場合があります。