

側面図 S=1/20

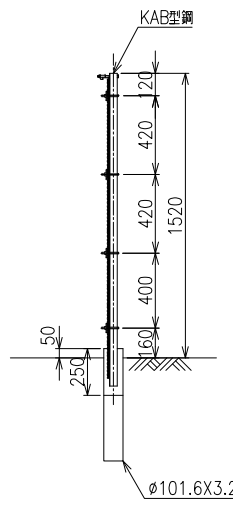

片開き門扉 S=1/20

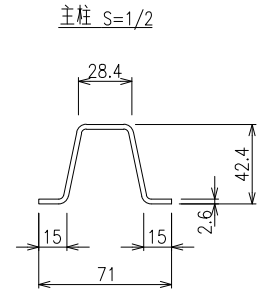
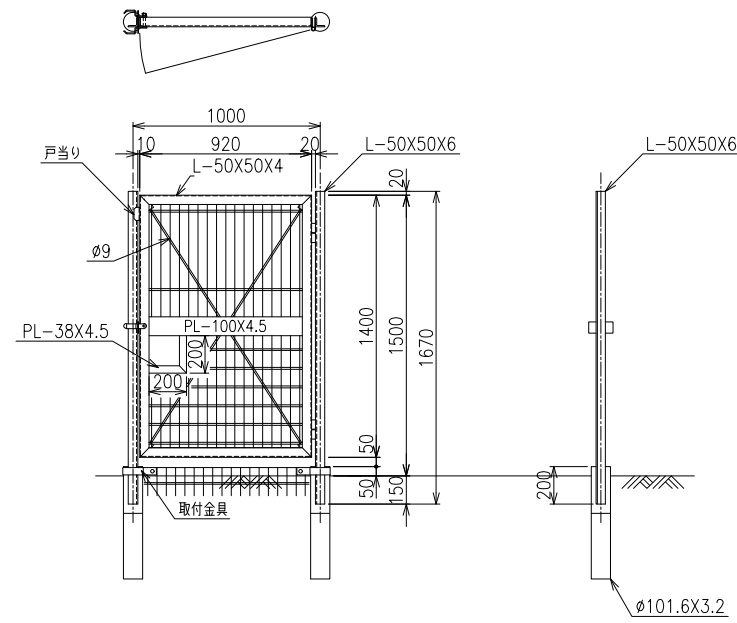

胴縁 S=1/2

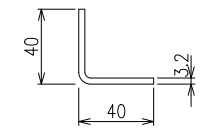

端柱 S=1/2

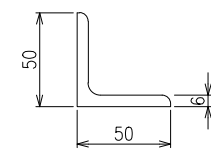

\*鋼管基礎長は、設計基準ごとに異なります。

隅柱取付詳細図 S=1/3

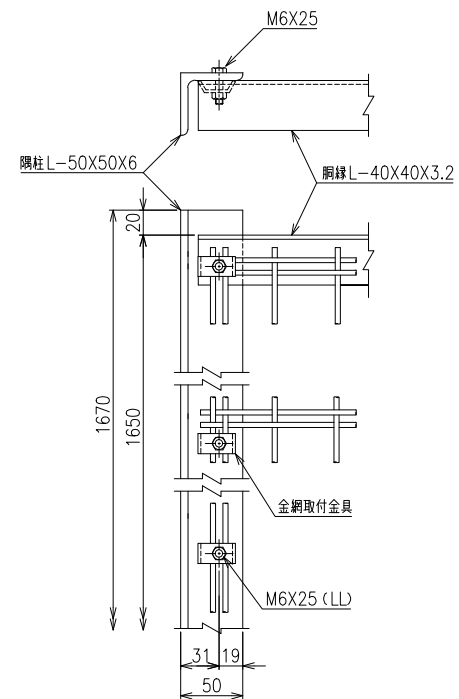

主柱胴縁取付詳細図 S=1/4

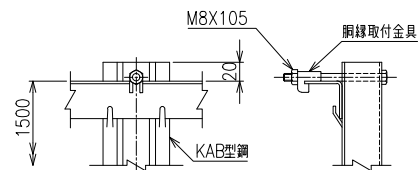

A部詳細図 S=1/4

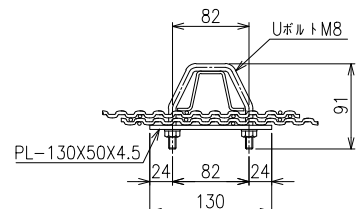

クリップ金網取付詳細図 S=1/3

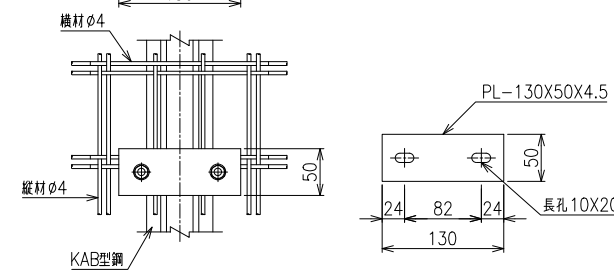
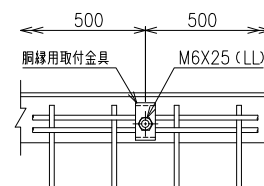

動物侵入防止柵用クリップ金網 S=1/20

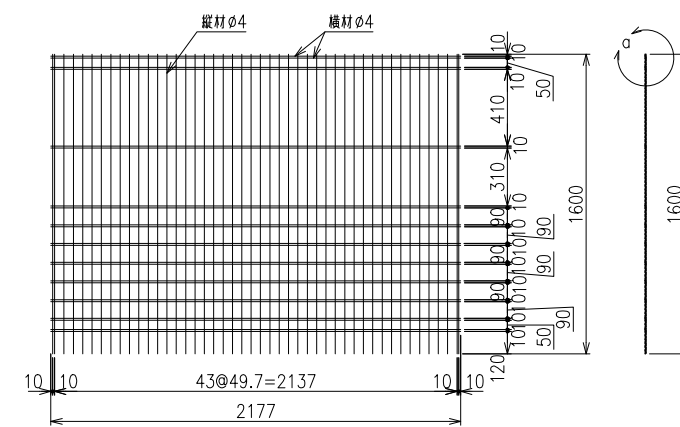

O部詳細図 S=1/4

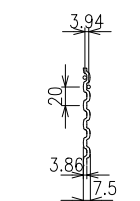

胴縁取付金具 S=1/1

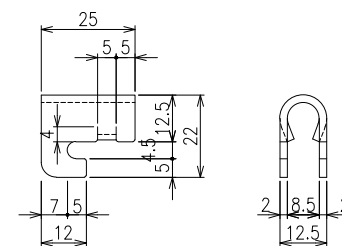

胴縁 S=1/4

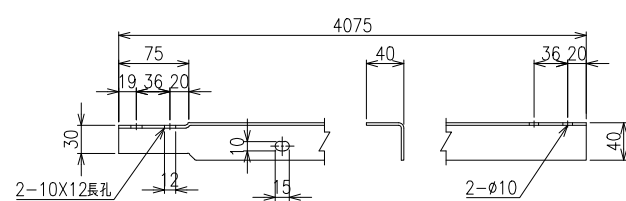

胴縁継手詳細図 S=1/4

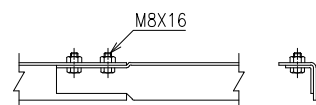

Uボルト、ナット S=1/2

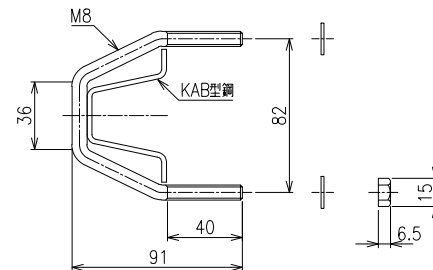

胴縁用金網取付金具 S=1/2

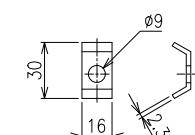

\*出力する用紙サイズにより、表示された縮尺とは異なる場合があります。